

XP1802

General Purpose Explosion Proof Motor

Class I, Division I, Groups C & D and Class II, Division I, Groups E, F and G - Operating Temperature Code: T3C

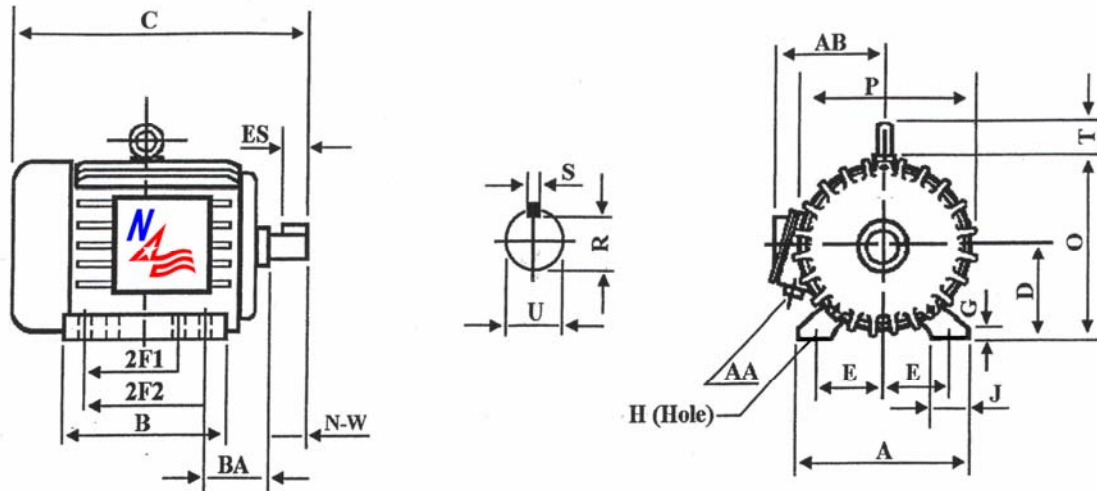

DIMENSIONS – INCHES

A	B	C	D	E	2F1	2F2	G	H	J	O
7	6.9	14.6	3.5	5.5	4	5	0.5	0.3	1.4	7.6
P	R	S	T	U	ES	AA	AB	BA	N-W	Mount
7.5	0.771	0.188	1.6	0.875	1.41	0.75	6.9	2.25	2.25	F1

PERFORMANCE DATA

Three Phase – 60Hz - 208-230/460V – NEMA Design B – Max. Ambient: 40° C

HP	Speed	Frame	NEMA Code	Efficiency (%)			Power Factor			Torque (ft-lb)		
				100%	75%	50%	100%	75%	50%	FLT	BDT	LRT
2	1751	145T	K	84.0	86.1	85.0	0.830	0.732	0.599	6.0	16.8	14.6
Amps (460V)		DE Bearing	ODE Bearing	Insulation Class	Enclosure Type	Service Factor	Weight (lbs)					
FLA	LRA											
2.7	25	6205-ZZ	6205-ZZ	F	TEFC	1.15	74					





50Hz AND 60Hz DATA FOR 3 PHASE AC INDUCTION MOTOR AS IT APPEARS ON THE NAMEPLATE.

XP1802

CAT. NO: XP1802		FRAME: 145T		ENCL: TEFC		PHASE: 3	
SHAFT END BRG: 6205-ZZ				OPP/END BRG: 6205-ZZ			
MAX. AMB: 40° C		INS CLASS: F		RATING: CONT.		MOTOR WEIGHT: 74LBS	
USABLE ON 208V 60HZ AT: 6.0 MAX. AMPS						SER:	
DIVISION I, CASS I, GROUPS C & D CLASS II, GROUPS E, F & G						OP TEMP CODE: T3C	
60 HERTZ DATA	HP: 2 RPM: 1751			HP: 2 RPM: 1425			50 HERTZ DATA
	VOLTAGE: 230/460V			VOLTAGE: 190/380V			
	F. L. AMPS: 5.4/2.7			F. L. AMPS: 6.44/3.22			
	S.F. AMPS: 6.2/3.1			S.F. AMPS: 6.44/3.22			
	S.F. 1.15	DESIGN: B	CODE: K	S.F. 1.0	DESIGN:	CODE: M	
	NEMA NOM. EFF: 84.0%			NEMA NOM. EFF: 81.5%			
	NOM. P. F.: 0.83			NOM. P. F.: 0.868			
	NEMA MIN. EFF.: 81.5%			NEMA MIN. EFF.: 78.5%			
	MAX. KVAR: 1.08			MAX. KVAR: 0.82			

Note: F.L. = Full Load P.F. = Power Factor S.F. = Service Factor



North American Electric, Inc. 350 Vaiden Drive, Hernando, MS 38632
 Toll Free: 1-800-884-0405 Phone: 662-429-8049 Fax: 662-429-8546
www.northamericanelectric-inc.com