

XP1815

General Purpose Explosion Proof Motor

Class I, Division I, Groups C & D and Class II, Division I, Groups E, F and G - Operating Temperature Code: T3C

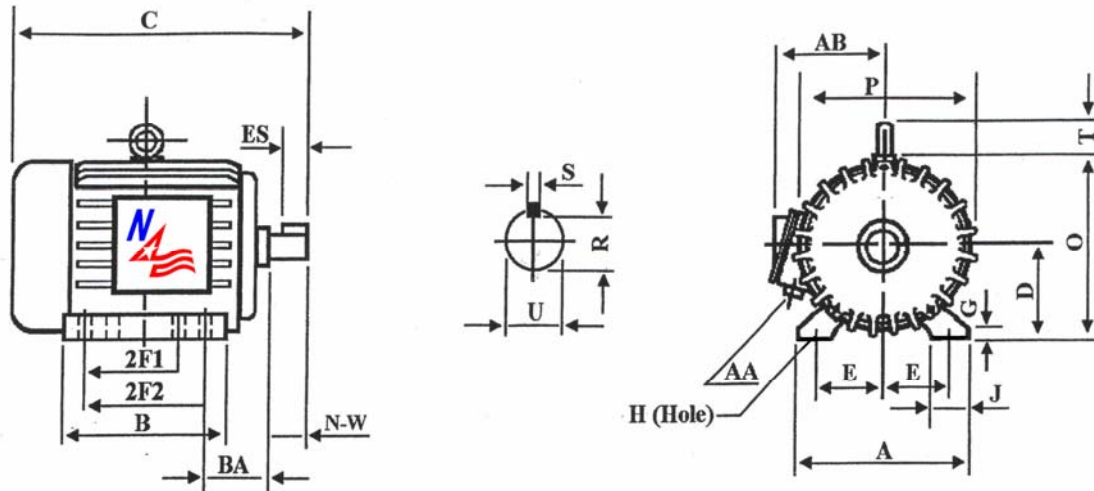

DIMENSIONS – INCHES

A	B	C	D	E	2F1	2F2	G	H	J	O
12.5	12.5	26.2	6.25	10	8.25	10	0.9	0.5	2.8	13.4
P	R	S	T	U	ES	AA	AB	BA	N-W	Mount
14.1	1.416	0.375	2.4	1.625	2.91	1.25	13.6	4.25	4	F1

PERFORMANCE DATA

Three Phase – 60Hz - 208-230/460V – NEMA Design B – Max. Ambient: 40° C

HP	Speed	Frame	NEMA Code	Efficiency (%)			Power Factor			Torque (ft-lb)		
				100%	75%	50%	100%	75%	50%	FLT	BDT	LRT
15	1765	254T	G	91.0	92.1	92.1	0.892	0.877	0.804	44.63	91.6	73.7
Amps (460V)		DE Bearing	ODE Bearing	Insulation Class	Enclosure Type	Service Factor	Weight (lbs)					
FLA	LRA											
17.0	116	6309	6309	F	TEFC	1.15	393					



North American Electric, Inc. 350 Vaiden Drive, Hernando, MS 38632

Toll Free: 1-800-884-0405 Phone: 662-429-8049 Fax: 662-429-8546

www.northamericanelectric-inc.com



50Hz AND 60Hz DATA FOR 3 PHASE AC INDUCTION MOTOR AS IT APPEARS ON THE NAMEPLATE.

XP1815

CAT. NO: XP1815		FRAME: 254T		ENCL: TEFC		PHASE: 3	
SHAFT END BRG: 6309				OPP/END BRG: 6309			
MAX. AMB: 40° C		INS CLASS: F		RATING: CONT.		MOTOR WEIGHT: 393LBS	
USABLE ON 208V 60HZ AT: 37.6 MAX. AMPS						SER:	
DIVISION I, CASS I, GROUPS C & D CLASS II, GROUPS E, F & G						OP TEMP CODE: T3C	
60 HERTZ DATA	HP: 15 RPM: 1765			HP: 15 RPM: 1455			50 HERTZ DATA
	VOLTAGE: 230/460V			VOLTAGE: 190/380V			
	F. L. AMPS: 34.0/17.0			F. L. AMPS: 42.0/21.0			
	S.F. AMPS: 39.1/19.6			S.F. AMPS: 42.0/21.0			
	S.F. 1.15	DESIGN: B	CODE: G	S.F. 1.0	DESIGN:	CODE: H	
	NEMA NOM. EFF: 91.0%			NEMA NOM. EFF: 89.5%			
	NOM. P. F.: 0.892			NOM. P. F.: 0.889			
	NEMA MIN. EFF.: 89.0%			NEMA MIN. EFF.: 87.5%			
	MAX. KVAR: 4.30			MAX. KVAR: 3.76			

Note: F.L. = Full Load P.F. = Power Factor S.F. = Service Factor



North American Electric, Inc. 350 Vaiden Drive, Hernando, MS 38632
Toll Free: 1-800-884-0405 Phone: 662-429-8049 Fax: 662-429-8546
www.northamericanelectric-inc.com