

NA184T-5-2

General Purpose Hostile Duty Motor

Energy Efficient – Three Phase – TEFC - AC Motor - Inverter Rated (10:1 VT; 5:1 CT)

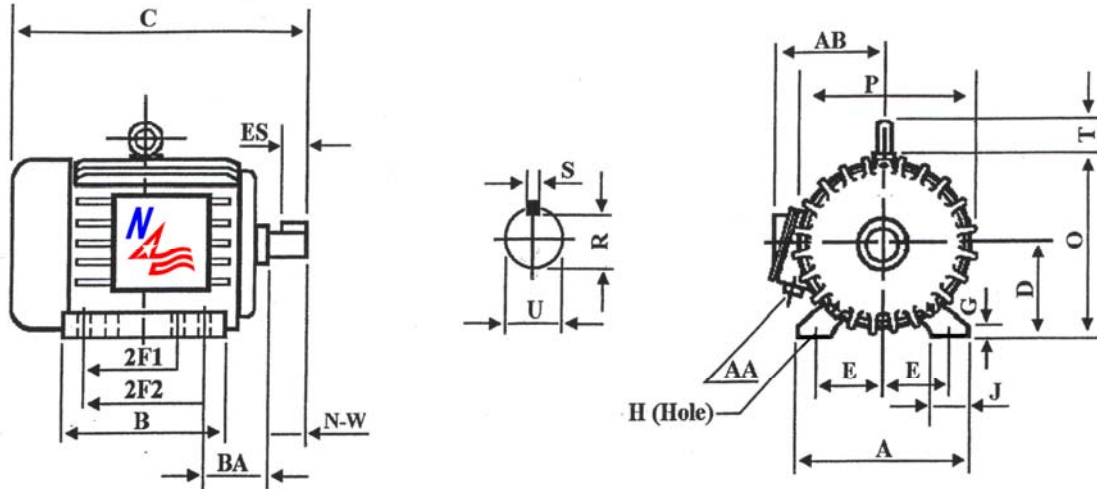

DIMENSIONS – INCHES

A	B	C	D	E	2F1	2F2	G	H	J	O
9.5	7.3	16.1	4.5	3.75	4.5	5.5	0.7	.41	2.04	9.1
P	R	S	T	U	ES	AA	AB	BA	N-W	Mount
8.7	.986	.250	1.6	1.125	1.78	.75	7.5	2.75	2.75	F1

PERFORMANCE DATA

Three Phase – 60Hz - 208-230/460V – NEMA Design B - Max. Ambient: 40° C

HP	Speed	Frame	NEMA Code	Efficiency (%)			Power Factor (%)			Torque (ft-lb)		
				100%	75%	50%	100%	75%	50%	FLT	BDT%	LRT%
5	3515	184T	J	87.5	88.0	87.8	90.0	90.0	82.0	7.46	290	200
Amps (460V)		DE Bearing	ODE Bearing	Insulation Class	Enclosure Type	Service Factor	Weight (lbs)					
FLA	LRA											
6.0	46.0	6306ZZ	6306ZZ	F	TEFC	1.15	103					



North American Electric, Inc. 350 Vaiden Drive, Hernando, MS 38632

Toll Free: 1-800-884-0405 Phone: 662-429-8049 Fax: 662-429-8546

www.naemotors.com