

NA213T-7.5-2

General Purpose Hostile Duty Motor

Energy Efficient – Three Phase – TEFC - AC Motor - Inverter Rated (10:1 VT; 5:1 CT)

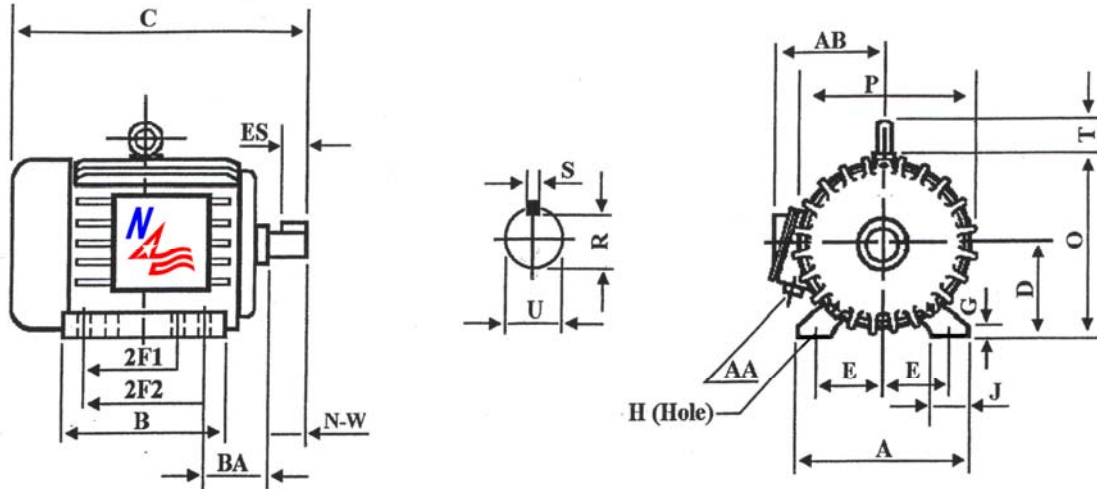

DIMENSIONS – INCHES

A	B	C	D	E	2F1	2F2	G	H	J	O
11.0	7.9	18.9	5.25	4.25	5.5	N/A	0.8	.41	2.45	10.5
P	R	S	T	U	ES	AA	AB	BA	N-W	Mount
10.2	1.201	.312	1.90	1.375	2.41	1.0	8.30	3.5	3.38	F1

PERFORMANCE DATA

Three Phase – 60Hz - 208-230/460V – NEMA Design B - Max. Ambient: 40° C

HP	Speed	Frame	NEMA Code	Efficiency (%)			Power Factor (%)			Torque (ft-lb)		
				100%	75%	50%	100%	75%	50%	FLT	BDT%	LRT%
7.5	3525	213T	H	88.5	89.0	89.0	91.0	90.0	85.0	11.2	270	190
Amps (460V)		DE Bearing	ODE Bearing	Insulation Class	Enclosure Type	Service Factor	Weight (lbs)					
FLA	LRA											
8.8	63	6308ZZ	6308ZZ	F	TEFC	1.15	138					



North American Electric, Inc. 350 Vaiden Drive, Hernando, MS 38632

Toll Free: 1-800-884-0405 Phone: 662-429-8049 Fax: 662-429-8546

www.naemotors.com