

D143T1.5M2A

General Purpose, Three Phase, Open Dripproof

High starting Torque – Dual Drilled feet -- Rolled Steel --AC Motor

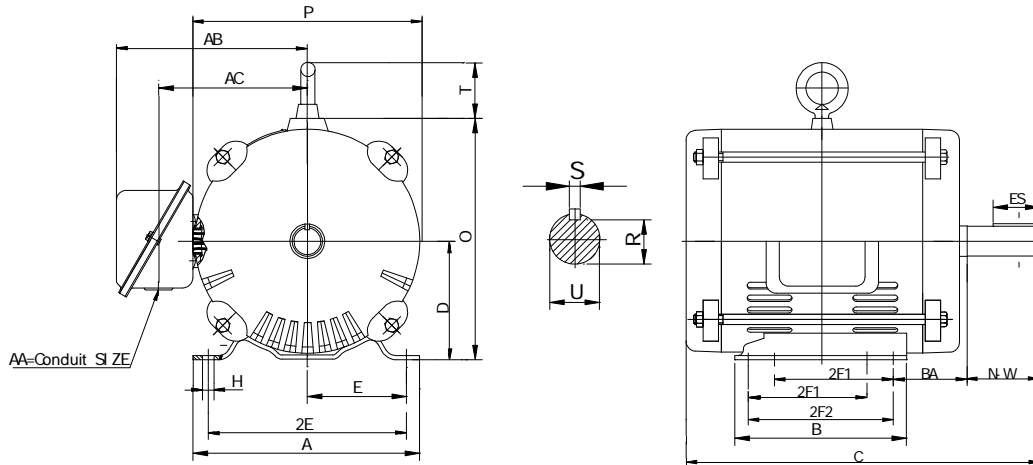

DIMENSIONS – INCHES

A	B	C	D	E	2F1	2F2	G	H	AC	O
7.0	6.0	11.8	3.5	2.75	4.0	5.0	NA	.34	4.9	7.09
P	R	S	T	U	ES	AA	AB	BA	N-W	Mount
6.89	.771	.188	1.57	.875	1.41	1.10	6.5	2.25	2.25	F1

PERFORMANCE DATA

Three Phase – 60Hz - 208-230/460V – NEMA Design B - Max. Ambient: 40° C

HP	Speed	Frame	NEMA Code	Efficiency (%)			Power Factor			Torque (ft-lb)		
				100%	75%	50%	100%	75%	50%	FLT	BDT	LRT
1.5	3500	143T	M	82.5	84.7	83.6	78.0	76.4	73.9	2.3	270	310
Amps (460V)		DE Bearing	ODE Bearing	Insulation Class	Enclosure Type	Service Factor	Weight (lbs)					
FLA	LRA											
2.1	20.0	6205ZZ	6203ZZ	B	ODP	1.15	37					