

D182T5M2A

General Purpose, Three Phase, Open Dripproof

High starting Torque – Dual Drilled feet -- Rolled Steel --AC Motor

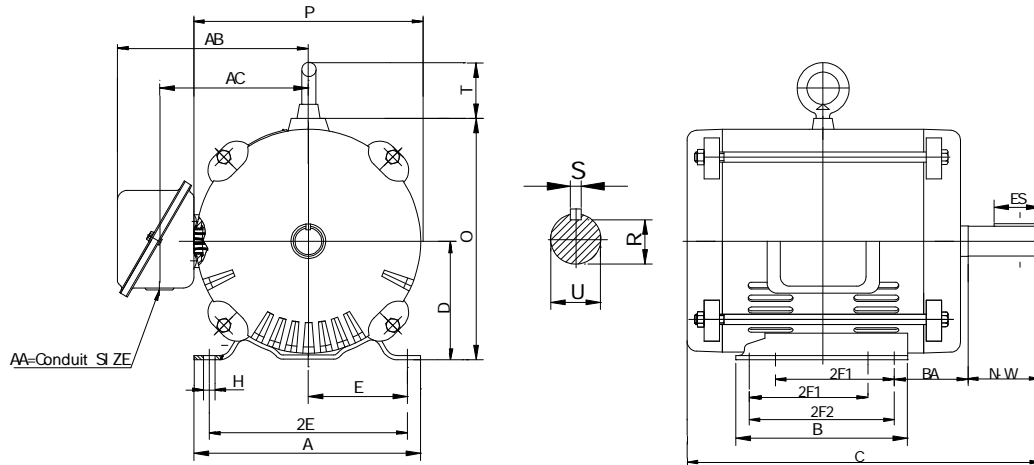

DIMENSIONS – INCHES

A	B	C	D	E	2F1	2F2	G	H	AC	O
9.0	6.7	13.8	4.5	3.75	4.5	5.5	NA	.41	5.7	9.25
P	R	S	T	U	ES	AA	AB	BA	N-W	Mount
8.66	.986	.25	1.97	1.125	1.78	1.1	7.3	2.75	2.75	F1

PERFORMANCE DATA

Three Phase – 60Hz - 208-230/460V – NEMA Design B - Max. Ambient: 40° C

HP	Speed	Frame	NEMA Code	Efficiency (%)			Power Factor			Torque (ft-lb)		
				100%	75%	50%	100%	75%	50%	FLT	BDT	LRT
5	3510	182T	J	85.5	86.4	85.1	85.0	83.6	80.7	7.5	215	150
Amps (460V)		DE Bearing	ODE Bearing	Insulation Class	Enclosure Type	Service Factor	Weight (lbs)					
FLA	LRA											
6.4	46.0	6206ZZ	6206ZZ	F	ODP	1.15	73					

