

## NAE-VHS-15-4

### NEMA Standard Vertical Hollow Shaft Motor

Energy Efficient – Three Phase – ODP – WP1 -- AC Motor – 10 to 1 Variable Torque

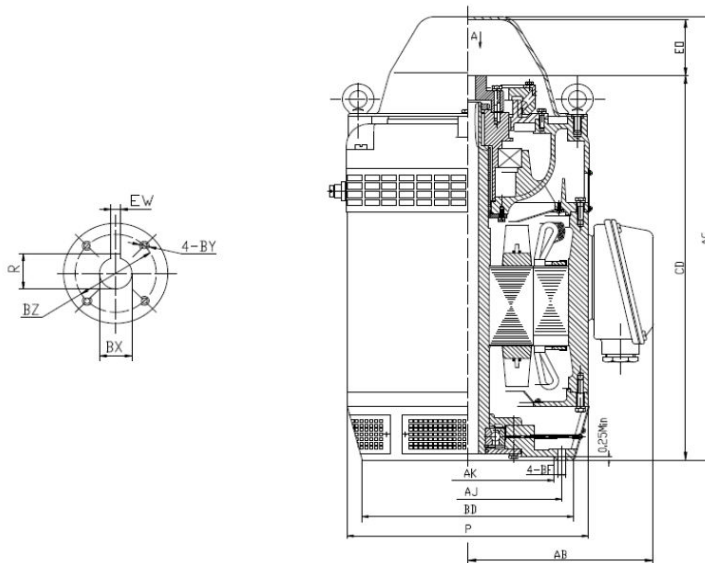

#### DIMENSIONS – INCHES

BD	AJ	AK	BF	BZ	EW	R	BY	CD	EO >	AC
10.0	9.125	8.25	0.44	1.38	0.25	1.13	10-32	23.38	3.22	10.6
AA	AF	P	AB	AG	Upper Bearing Oil Capacity		Down Thrust	BX		
1.25	3.98	13.6	14.06	26.8	NA		3200 lbs	1.0		

NOTE: Optional BX Coupling Dimensions Available.

#### PERFORMANCE DATA

Three Phase – 60Hz - 230/460V – NEMA Design B - Max. Ambient: 40° C

HP	Speed	Frame	NEMA Code	Efficiency (%)			Power Factor %			Torque (ft-lb)		
				100%	75%	50%	100%	75%	50%	FLT	BDT%	LRT%
15	1770	254TP	C	86.5	86.1	85.3	85.0	82.0	73.0	59.4	246	203
Amps ( 460V)		Angular Contact Bearing	Radial Ball Bearing	Insulation Class	Enclosure Type	Service Factor	Weight (lbs)					
FLA	LRA											
18.52	116.25	7312B	6212	F	ODP	1.15	548					

North American Electric, Inc. 350 Vaiden Drive, Hernando, MS 38632

Toll Free: 1-800-884-0405 Phone: 662-429-8049 Fax: 662-429-8546

[www.naemotors.com](http://www.naemotors.com)