

NAE-VHS-75-4

NEMA Standard Vertical Hollow Shaft Motor

Energy Efficient – Three Phase – ODP – WP1 – AC Motor – 10 to 1 Variable Torque

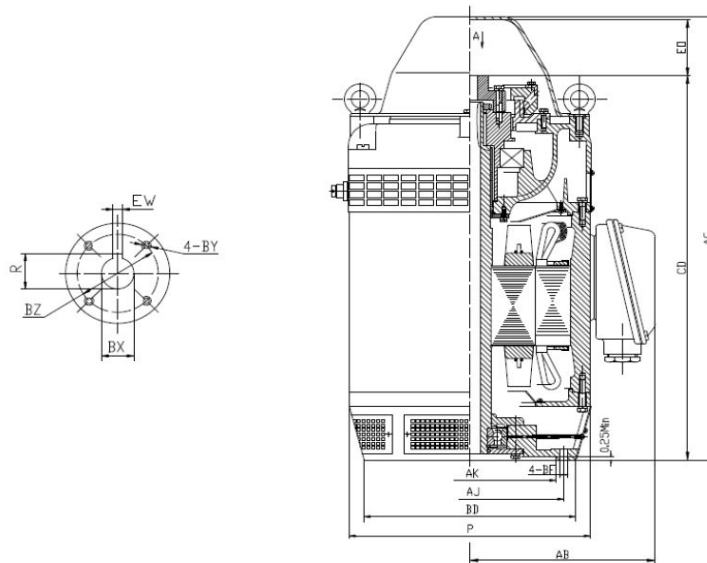

DIMENSIONS – INCHES

BD	AJ	AK	BF	BZ	EW	R	BY	CD	EO >	AC
16.5	14.75	13.5	0.69	1.75	0.25	1.367	1/4-20	31.16	4.56	12.56
AA	AF	P	AB	AG	Upper Bearing Oil Capacity		Down Thrust	BX		
3.0	5.83	19.1	15.9	36.0	4.2		5600 lbs	1.25		

NOTE: Optional BX Coupling Dimensions Available.

PERFORMANCE DATA

Three Phase – 60Hz - 230/460V – NEMA Design B - Max. Ambient: 40° C

HP	Speed	Frame	NEMA Code	Efficiency (%)			Power Factor %			Torque (ft-lb)		
				100%	75%	50%	100%	75%	50%	FLT	BDT%	LRT%
75	1770	365TP	C	92.3	91.7	91.4	87.0	88.0	84.0	297.2	251	227
Amps (460V)		Angular Contact Bearing	Radial Ball Bearing	Insulation Class	Enclosure Type	Service Factor	Weight (lbs)					
FLA	LRA											
86.02	591.1	7224B	6314	F	ODP	1.15	1075					

North American Electric, Inc. 350 Vaiden Drive, Hernando, MS 38632

Toll Free: 1-800-884-0405 Phone: 662-429-8049 Fax: 662-429-8546

www.naemotors.com