

NA213JM-7.5-4

Special Purpose JM Frame Close-Coupled Pump Motor

Energy Efficient – Three Phase – TEFC - AC Motor - Inverter Rated (10:1 VT; 5:1 CT)

DIMENSIONS – INCHES

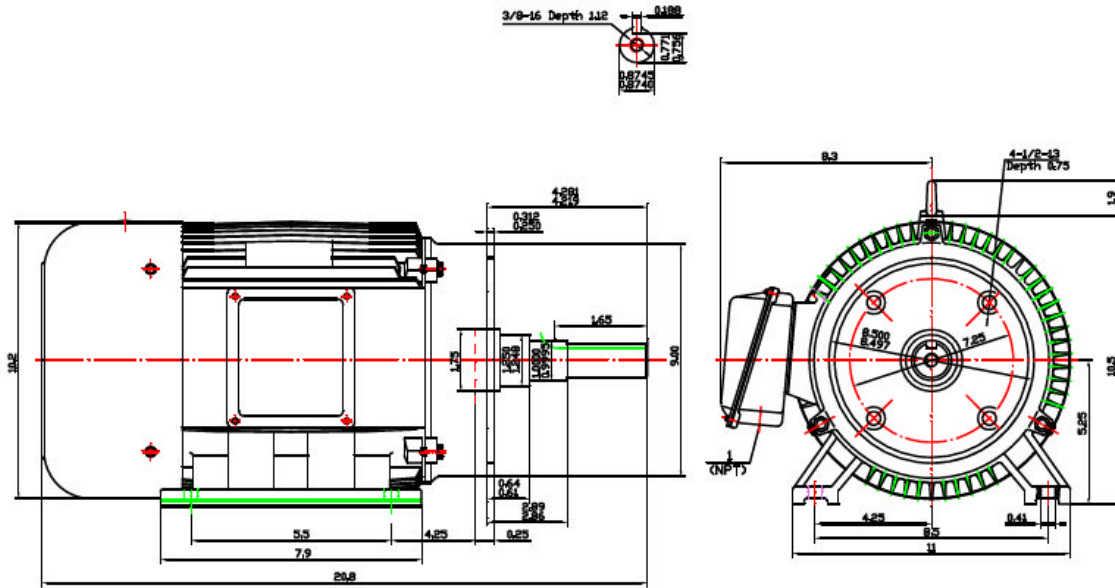

PERFORMANCE DATA

Three Phase – 60Hz - 208-230/460V – NEMA Design B - Max. Ambient: 40° C

HP	Speed	Frame	NEMA Code	Efficiency (%)			Power Factor (%)			Torque (ft-lb)		
				100%	75%	50%	100%	75%	50%	FLT	BDT%	LRT%
7.5	1750	213JM	H	89.5	89.7	89.6	85.0	84.0	75.0	22.5	260	200
Amps (460V)		DE Bearing	ODE Bearing	Insulation Class	Enclosure Type	Service Factor	Weight (lbs)					
FLA	LRA											
9.2	63	6308ZZ	6308ZZ	F	TEFC	1.15	139					



North American Electric, Inc. 350 Vaiden Drive, Hernando, MS 38632

Toll Free: 1-800-884-0405 Phone: 662-429-8049 Fax: 662-429-8546

www.naemotors.com