

H18300U

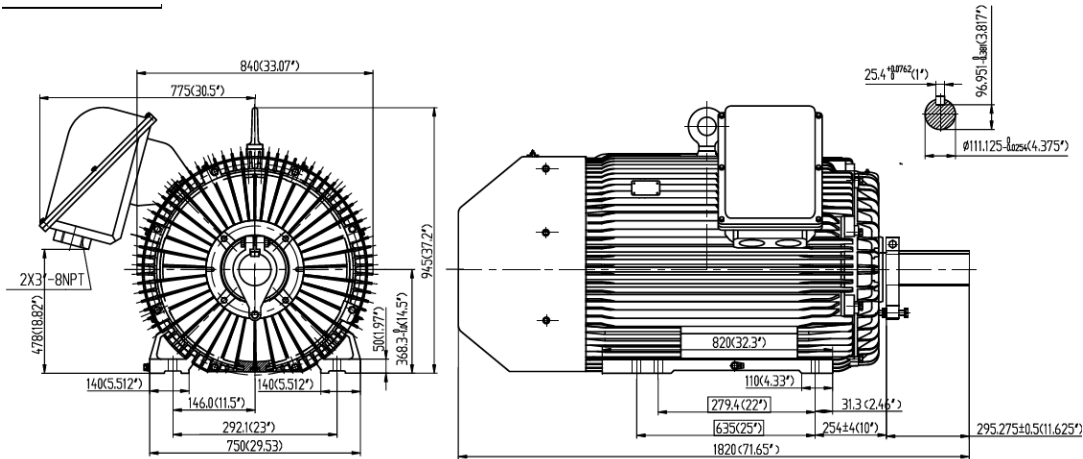

STANDARD FEATURES

- 4160 Steel Shaft, all Cast Iron Construction including Fan Cover
- High Breakdown Torque (NEMA Design C).
- Conduit Box Positioned to maximize cooling efficiency.
- Three Phase, 460V only, 60Hz.
- Capable of Wye-Delta and Part Wind across the line start (12 Lead).
- Terminal Block provided for easy installation.
- Labyrinth Seals as Standard, TEFC, IP55 protection.
- Class F Insulation System with Class H epoxy resin wire.
- 10 to 1 Variable Torque – 5 to 1 Constant Torque, 1.15 Service Factor.
- Roller bearings on all crusher duty models on drive end (Ball Bearings optional).
- Space Heaters and Thermostats with separate terminal block standard.

HP	Speed	Frame	NEMA Code	Efficiency (%)			Power Factor (%)			Torque (ft-lb)		
				100%	75%	50%	100%	75%	50%	FLT	BDT%	LRT%
300	1789	586/7U	F	96.0	95.2	94.8	88.7	88.0	82.5	868.1	254	203
Amps (460V)		DE Bearing	ODE Bearing	Insulation Class	Enclosure Type	Service Factor	Weight (lbs)					
FLA	LRA											
325.1	2103	NU324	6319	F	TEFC	1.15	4625					

