

H18400UZ

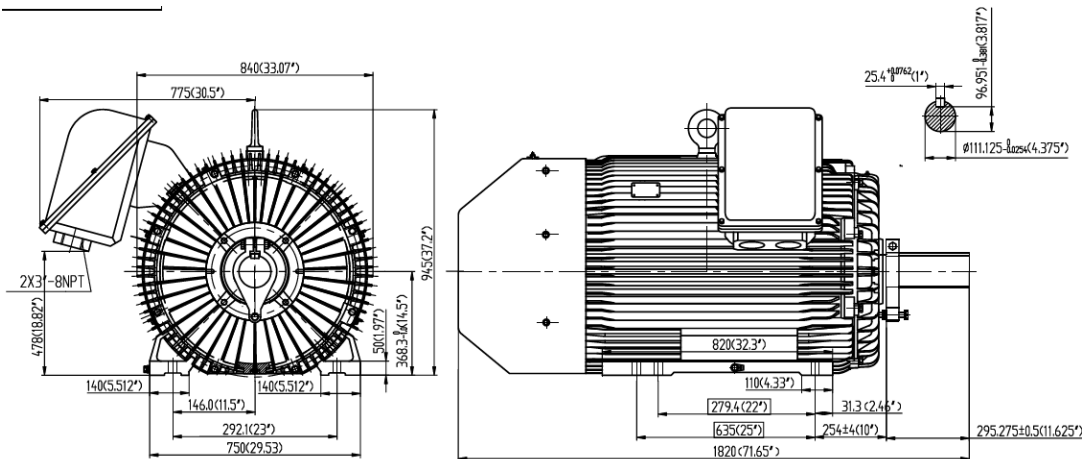

STANDARD FEATURES

- 4160 Steel Shaft, all Cast Iron Construction including Fan Cover
- High Breakdown Torque (NEMA Design A).
- Conduit Box Positioned to maximize cooling efficiency.
- Three Phase, 460V only, 60Hz.
- Capable of Wye-Delta and Part Wind across the line start (12 Lead).
- Terminal Block provided for easy installation.
- Labyrinth Seals as Standard, TEFC, IP55 protection.
- Class F Insulation System with Class H epoxy resin wire.
- 10 to 1 Variable Torque – 5 to 1 Constant Torque, 1.15 Service Factor.
- Roller bearings on all crusher duty models on drive end (Ball Bearings optional).
- Space Heaters and Thermostats with separate terminal block standard.

HP	Speed	Frame	NEMA Code	Efficiency (%)			Power Factor (%)			Torque (ft-lb)		
				100%	75%	50%	100%	75%	50%	FLT	BDT%	LRT%
400	1789	586/7UZ	G	96.3	95.7	95.3	89.0	88.7	83.6	1183.8	252	223
Amps (460V)		DE Bearing	ODE Bearing	Insulation Class	Enclosure Type	Service Factor	Weight (lbs)					
FLA	LRA											
440.2	2938	NU324	6319	F	TEFC	1.15	4982					

